

ENGINEERING
TOMORROW

Danfoss

Global Master Catalog

Flexmaster® joint connectors

Conveying products





Table of Contents

The concept	4
Features	5
Possible applications	7
Special configurations	8
Planning and routing	10
Assembly instructions	11
Operating pressure, chemical resistance, temperatures	12
Technical Data	13
How to order AMER region part numbers	15
Technical Data - Parts list	16
Joints for Rigid Pipe	18
Joints for Inch-Size Tube	22
Technical data for EMEA region part numbers	27
Flexmaster, Straight	28
Flexmaster Individual Components	29
Flexmaster, Straight	30
Flexmaster Individual Components	31

The concept

The Flexmaster range consists of tube/ pipe joints for the low pressure application. They are ideal for producing leak-proof connections between pipe ends. They can also provide compensation for alignment errors of pipes in installations and can absorb relative movement of pipes.

The connector consists of 7 metal components, 2 sealing rings and 4 bolts with self-locking nuts.

The most important components for correct operation of Flexmaster pipe joints are the two sealing rings. They have the following functions:

1. Sealing up to an operating pressure of max. 15 bar with all connectors in product range (see page 12).
2. Compensation of possible alignment errors of pipes to be connected up to $\pm 4^\circ$, up to $\pm 2^\circ$ for EMEA region parts.

3. Compensation for or absorption of vibration.
4. Absorption to a certain degree of axial displacements of pipes caused by temperature fluctuations or external mechanical influences.
5. Chemical resistance to media specified by us.

Standard designs of Flexmaster are supplied with sealing rings made of perburian (NBR). These can be used with commercial mineral oils and water at temperatures from -40°C to $+110^\circ\text{C}$ (for brief periods also up to $+120^\circ\text{C}$). With hot air, these sealing rings can be used only at temperatures up to $+70^\circ\text{C}$ (see also temperature table on page 12).

Special sealing rings made of fluorelastomer (FPM) are available for use at higher medium temperatures of up to $+230^\circ\text{C}$.



Features

Flexmaster Joints in Standard and Self-restrained Configurations

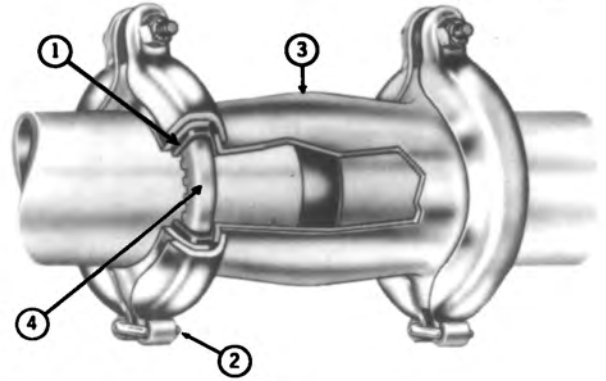
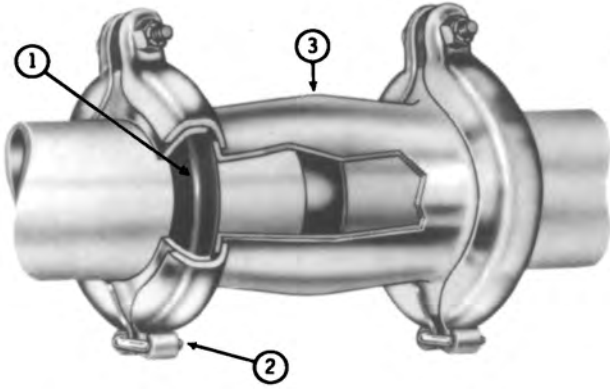

Standard Features

1. Gasket provides compression seal when tightened against tube or pipe.
2. Hinged coupling provides for quick, easy assembly.
3. Bulged sleeve allows for $\pm 4^\circ$ angular misalignment. All gasket materials listed on page 4 are available in the standard style, increasing the number of suitable applications.

Flexmaster joints are available in both standard and self-restrained styles. The self-restrained style has a stainless steel gripping ring inside each gasket. This feature allows the joint to maintain a firm grip on the pipe or tube, preventing movement along the pipe or tube.

The bulged, straight-through Flexmaster joints accommodate angular misalignment up to $\pm 4^\circ$ per end. Tees, elbows, and crosses accommodate angular misalignment up to $\pm 4^\circ$ per end (up to $\pm 2^\circ$ for EMEA parts). See pages 18 thru 25 for the angular misalignment allowed on each specific part. Flexmaster joints are designed for up to 300 psi (20 bar) service, depending on application and size. Refer to pressure ratings on page 13.

Self-Restrained Features

1. Gasket provides compression seal when tightened against tube or pipe.
2. Hinged coupling provides for quick, easy assembly.
3. Bulged sleeve allows for $\pm 4^\circ$ angular misalignment.
4. Notched channel ring which grips pipe firmly to restrict movement along pipe or tubing.

Gasket materials available include the C (Buna-N) and D (EPDM) compounds.

Flexmaster joints absorb vibration and are ideal for making quick connections and disconnections when repairing or disassembling a system. They can be furnished with several types of gasket compounds and sleeve materials, including stainless steel for marine and corrosive applications.

Flexmaster joints are currently in use in thousands of applications throughout the world. For typical Flexmaster joint applications see photos on page 7.

Features

Save Time - Make Pipe And Tube Connection Easier

Used on Plain End Tube or Pipe

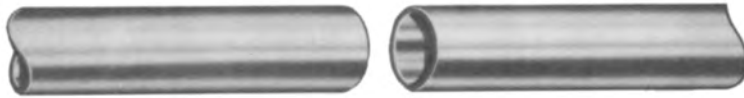

No threading, flanging, welding, grooving or other special end preparation of tube or pipe is required. Use pipe after it is cut to appropriate lengths. The Flexmaster joint will accommodate large tolerances in the length of the gap. See Table 1, page 17 for insertion depth tolerances.

Absorbs Vibration

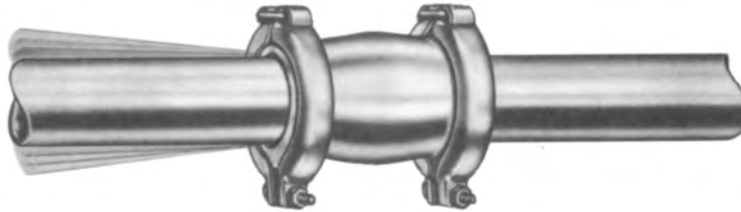

Pipe vibration and noise can be drastically reduced with Flexmaster joints. The resilient, thick rubber of the Flexmaster joint gasket absorbs vibration and noise. Use of the self-restrained style restricts movement along vibrating pipes and tubes.

Even Misaligned Piping is No Problem

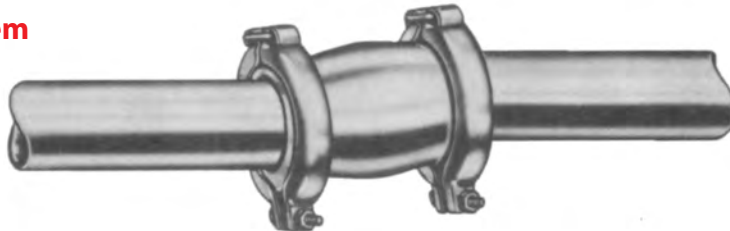

The Flexmaster joint design eliminates flanged bolt holes and pipe threads that require careful alignment. The Flexmaster bulged joint permits up to a total of $\pm 4^\circ$ angular installation misalignment at each end while maintaining a leakproof seal.

Easy to Install

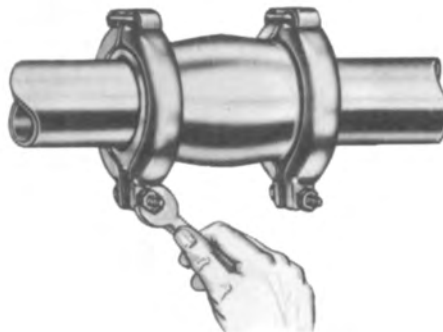

Installation time can be slashed by using Flexmaster joints. Basic assembly tools are all that's needed. After extensive use, the gaskets can be replaced easily and quickly. See page 13 for complete assembly instructions.

Possible applications

Many branches of industry use pipe/tube joints for pipeline construction. The following table lists some of the most common possible applications for Aeroquip Flexmaster but is naturally not exhaustive. The table is intended merely to provide users with suggestions for the solution to pipeline-construction problems.

User	Application
Large engine construction	Cooling-water, cooling-air systems
Large gear unit construction	Pipe/tube connection
Railway rolling-stock and locomotive construction, shipbuilding	Piping systems for cooling water, air supply
Heavy machine construction	Coolant lines, suction lines
Construction machinery, machine tools, pumps, conveyor systems, general machine construction	Hydraulic lines in low-pressure and suction systems
Chemical plant construction	Lines for water-treatment systems and similar
Power-station construction and boilermaking	General piping systems
Compressor construction	Connection of air lines
Refineries	Piping for supply systems
Repair workshops, fitters, etc.	Repair of defective pipelines without welding e. g. in cases where explosion hazard is present



Special configurations

Made to Order

Special Configurations and Seal Materials Can Be Ordered

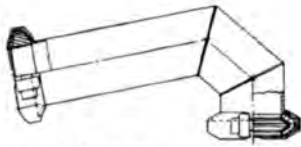

**Salt Water,
All 316 Stainless**

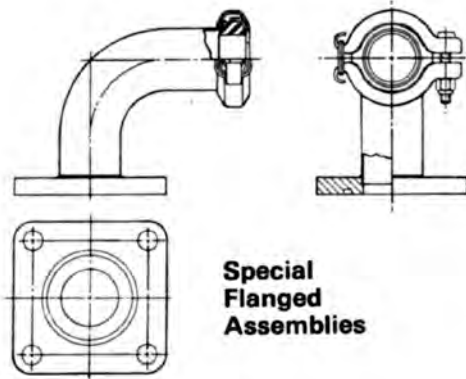

**Special
Flanged
Assemblies**

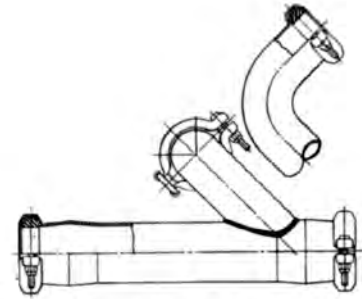

Lube Oil, Special Configuration

Flexmaster joints can be produced with various configurations and terminal end designs. A few of the special Flexmaster joint configurations which have been manufactured by Danfoss are displayed above. Please consult us when ordering specials.

Special configurations

Example of special characteristics

Special lengths

Special lengths for the standard tube diameters shown in this catalog are available on request in the following steps:

Standard length up to 200 mm: steps of 50 mm

>200 mm:

steps of 100 mm

Special designs

Special Flexmaster designs (i.e. welding-halves) might be available on request.

Special seals

Other materials beside NBR and FPM are available on request.

For the use on inch-size tubes special "self restrained" NBR seals are available on request.

Special materials

Solutions for special applications such as use with seawater or fresh water without additives are available on request.

Please contact Danfoss Service for details regarding special requests.

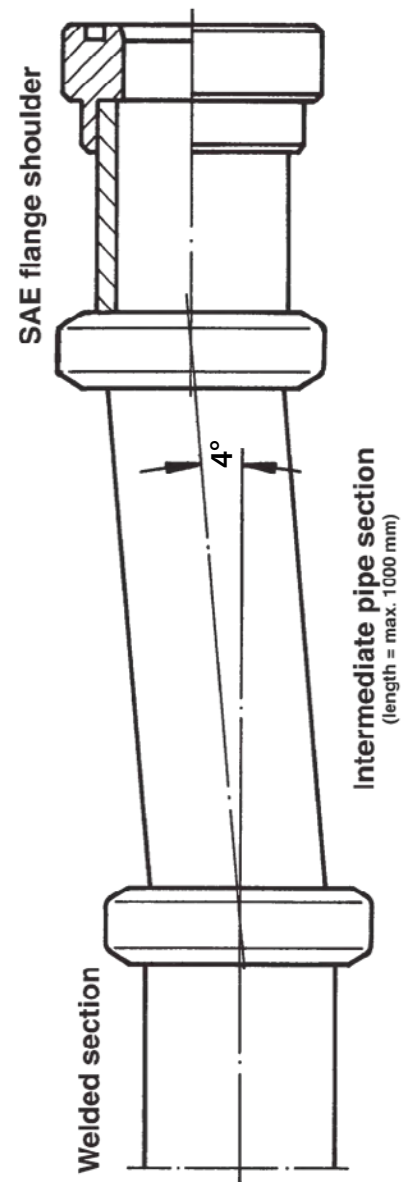
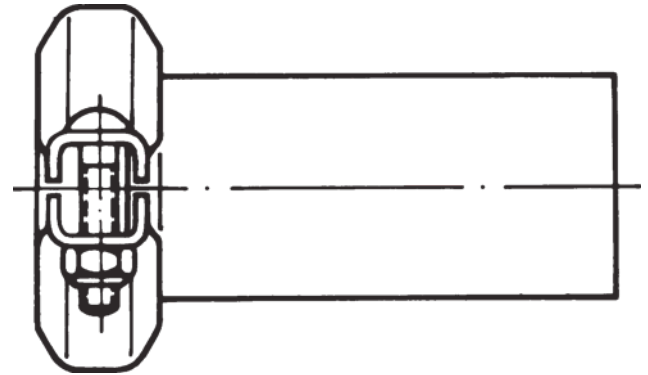

Planning and routing

In cases where it is planned to use Flexmaster in a piping system, the first step must be to answer the following questions:

1. **How high is the maximum pressure?**
2. **What compensation is required for alignment errors of the pipe ends?**
3. **How large will the axial movements of the pipes be?**
4. **What frequencies must be expected (e. g. with motor cooling systems)?**
5. **What medium and what temperature are to be used in the installation?**

The following pages are intended to help you plan the use of Flexmaster pipe connectors correctly with regard to these factors and to ensure that the connectors will operate satisfactorily when fitted.

In order to obtain correct operation after installation, the following should be taken into account when planning piping systems:

Flexmaster pipe joints must always be installed in such a way that they are accessible for periodic inspection.

During routing, it must be possible to push the Flexmaster sleeve onto the ends of the pipes to be connected before the pipes are permanently installed. The standard length should therefore be chosen in such a way that the minimum pipe-to-pipe distance "k" is sufficiently large to allow replacement of sealing rings without dismantling the pipes. Care should be taken to maintain the minimum insertion depth of the pipe ends "g".

At installation angles more than 45° to the vertical, Flexmaster must be secured by clips to prevent slipping.

During the routing of the elbow design of Flexmaster (45° or 90°), care must be taken with high liquid velocities to position the pipe support as close as possible to the pipe ends. The fitting of an additional support to prevent pulling away will ensure trouble-free operation even where high pulling away forces are present.

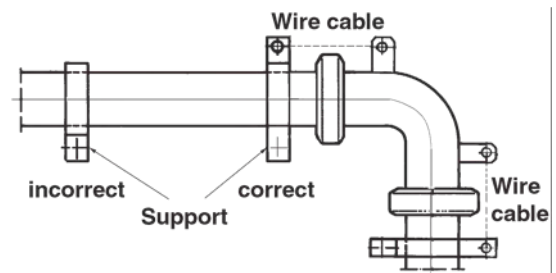
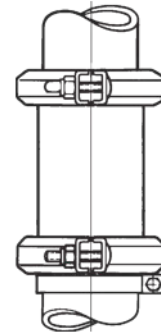
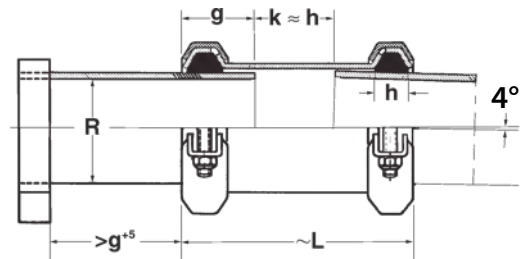

Assembly Instructions

Pipe and Tubing Preparation and Flexmaster Joint Installation Instructions

1. Pipe (Tube) End Preparation

- Deburr and clean pipe (tube) ends.
- Surface should be free of deep scratches, gouges, dents, dirt, etc.

2. Joint Installation

- Install retainer (1), gasket* (2) and sleeve (3) on one side of pipe in sequence shown in Figure 1.

- Install remaining retainer (4) and gasket (5) on other pipe end.
- Position retainer (4) and gasket (5) to proper pipe insertion depth ("D") as shown in Table 1.
- Slide sleeve (3) to gasket (5) and move gasket (2) and retainer (1) into position as shown in Figure 2. Pipe must be inserted to proper depth ("D") into both gaskets as shown in Table 1.

3. Special Notes

- Assembly of gaskets can be made easier by dipping gaskets in water or the fluid to be sealed. The use of other rubber lubricants can be detrimental to the life of the gaskets. Never lubricate the metal parts.
- Self-restrained gasket installation. To simplify installation of a self-restrained gasket, install lower gasket halfway onto the pipe first, leaving the split area in the steel retaining ring free at the top. See Figure 3. Then, stretch the gasket and split area of the retaining ring until they slip over the tube or pipe and into position. Refer to Figure 3.

4. Coupler Installation

- Install both V-couplings, encompassing the retainer, gasket and sleeve as shown in Figure 4. Do not tighten either coupling until the entire joint is assembled (See Figure 2). Tighten nuts to the torque specified in Table 2. Do NOT lubricate the nut or bolt before assembly. The gap method outline in Table 3 may be used for standard gaskets only.

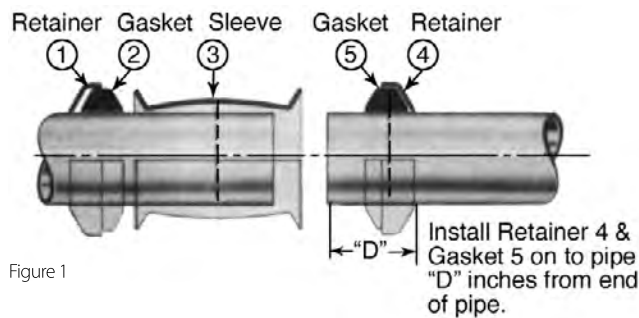

Figure 1

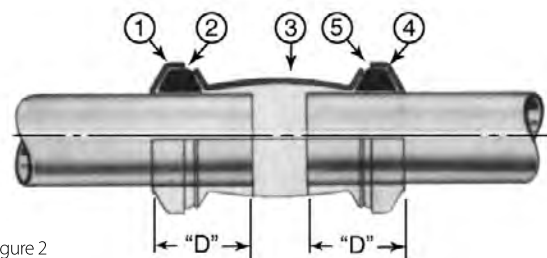

Figure 2

Attention: We recommend that the self-locking nuts should be replaced if they have been unscrewed and retightened several times.



WARNING Maximum temperature ratings are meant as a guide only. For extreme temperature conditions, consult factory. Improper installation, use or selection of the Flexmaster joints can result in personal injury, property damage or death.

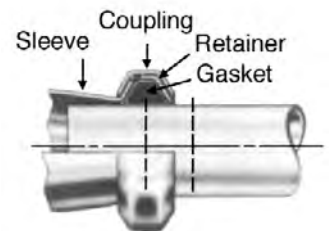
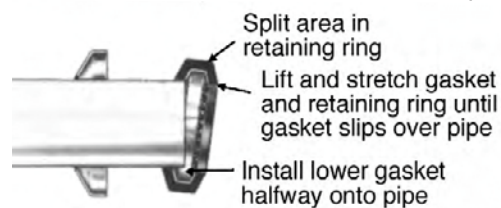

Figure 4



in notched retention ring sket is shown cut-away for clarity)



Figure 3

Operating pressure, chemical resistance, temperatures

In order to achieve a correct seal at the maximum operating pressure (15 bar), the pipe ends to be connected must be supported in such a way that any displacement forces which occur do not need to be absorbed by the sealing rings. The sealing rings cannot prevent the pipe ends from being pulled out of the Flexmaster. Under certain circumstances, protection against pulling-away must be provided.

If vibration is present, both radial (V) and axial (X) displacement of the pipe ends will occur; this must be absorbed by the sealing rings. Axial displacement is thus limited by the elasticity of the sealing rings; all Flexmaster connectors are nonetheless designed to be operated at the full operating pressure of 15 bar, even when the sealing rings are subjected to a flexing load (see below).

The temperature values given opposite refer to the chemical resistance of the standard perbunan (NBR) sealing rings.

Medium	Temperature
Commercial fuels	-40°C to + 40°C
Water, especially cooling water with additives	-35°C to + 95°C
Heating oils	-40°C to +110°C
Com. mineral oils, e. g. hydraulic fluids and lubricating oils	-40°C to +110°C
Air	-40°C to + 70°C
Waste water	Please consult us

For special applications such as those listed on the right, we recommend fluorelastomer (FPM) sealing rings, particularly at high temperatures (up to +230°C) or with aggressive media. Please consult us if necessary.

Medium	Temperature
Special gearbox oil	Please consult us, specifying oil type and temperature
Heavy heating oil	-30°C to +150°C
Warm air	-30°C to +150°C

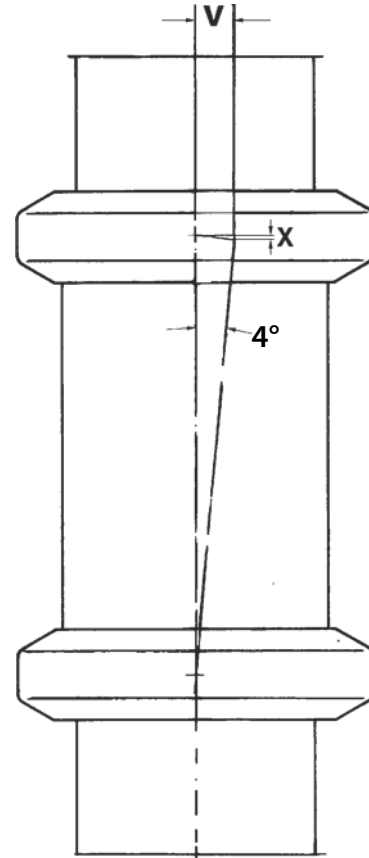

Surface protection of metal components

All Flexmaster components with the exception of sealing rings are generally made of steel with a galvanised surface (coating approx. 10-15 µ).

Technical Data

Gasket Temperature Ratings**

C BUNA-N (Standard)	water	-25° F. to +180° F. (-32° C. to +82° C.)
	oils	-25° F. to +215° F. (-32° C. to +121° C.)
V Fluorocarbon		-25° F. to +450° F. (-32° C. to +232° C.)
S Silicone		-65° F. to +350° F. (-54° C. to +177° C.)
D EPDM	water and water/glycol mixture	+20° F. to +275° F. (+29° C. to +137° C.)
G Mineral Fiber Non-asbestos		+70° F. to +1200° F. (+21° C. to +649° C.)
N BUNA-N (High temp.)	water and steam	-25° F. to +225° F. (-32° C. to +107° C.)
	oils	-25° F. to +250° F. (-32° C. to +121° C.)

** Maximum temperature ratings are meant as a guide only.
For extreme temperature conditions, consult factory.

Vacuum Ratings*

Size Range Pipe	Tube	Standard Gasket	Self-Restrained Gasket
All sizes	All sizes	25 in. Hg. 1.79 bar	25 in. Hg.

NOTE:

° F, inches, in. Hg., psi in bold

° C, mm, bar, MPa in light

Danfoss Gasket Identifier Chart

Gasket Designation Color Patch	Gasket Compound	Gasket Compound	Identifying Color
C	Buna N (std)	Black	Yellow or White
N	Buna N (high temp)	Black	Rust Orange
D	EPDM	Black	Dark Blue
V	Fluorocarbon	Black	Light Green
S	Silicone	Rust Orange	None
B***	Butyl	Off White	None
G***	Mineral Fiber	Metallic Silver	None

*** Obsolete

Pressure Ratings*

Size Range Pipe	Tube	Standard Gasket	Self-Restrained Gasket
3/8 - 3/4	1/2 - 1 3/8 12.7 - 35.1	300 psi (20 bar)	300 psi (20 bar)
1-2	1 1/2 - 2 1/2 38.1 - 63.5	200 psi (14 bar)	200 psi (14 bar)
2 1/2 - 6	3 - 6 76.2 - 152.4	150 psi (10 bar)	150 psi (10 bar)

*Warning: The Flexmaster joint is designed to seal pipe and tube connections. The Flexmaster joint is not intended to hold piping systems together. Normal hangers, guides, anchors and other external piping restraints must be used to restrain the piping or tubing system from movement.

For EMEA part numbers the maximum operating pressure is at 218 psi (15 bar).

Pipe and tube materials which can be connected by Flexmaster joints*

Pipe or Tube Material	Standard Gasket	Self-Restrained Gasket**
Carbon Steel	X	X
Stainless Steel	X	X
Aluminum	X	Not Recommended
P.V.C. (Plastic)	X	Not Recommended
Copper	X	Not Recommended

* All piping and tubing connected by Flexmaster joints must meet the nominal O.D. dimensions presented on pages 20 - 27.

** Piping and Tubing, which use self-restrained gaskets, must have a hardness between 45-85 on a Rockwell "B" scale (45 - 85 Rb).

Technical Data

Gasket Selector Chart

Gasket Material: C – BUNA-N (standard)
 D – EPDM
 N – BUNA-N
 (high temperature)
 V – Fluorocarbon
 S – Silicone

Key: G – GOOD
 F – FAIR
 – Not Recommended

An important consideration in the selection of a gasket material is to avoid undesirable chemical reaction between the agent carried and the gasket material. The gasket selector chart indicates the compound most serviceable in specific agents.

FLUID	GASKET MATERIAL			
	D	C/N	V	S
Acetic Acid (concentrated) RT	F	F	G	F
Acetic Acid (dilute) RT (to 10%)	F	F	G	G
Acetic Acid Vapors	F	F	F	F
Acedit Anhydride	-	F	-	F
Acetone	G	-	-	F
Acetylene	G	G	G	F
Air	G	G	G	G
Air (Hot) 215°	G	F	G	G
Alcohols, Aliphatic	G	F	G	G
Alcohols, Aromatic	F	-	F	F
Alkaline Solutions (Hydroxides)	F	G	F	G
Aluminum Salt solutions	G	G	G	G
Ammonia Gas (Cold)	G	G	-	-
Ammonia, Liquid (Anhydrous)	G	G	-	F
Ammonia Aqueous	G	F	-	G
Ammonium Salt Solutions	G	G	F	F
Aniline Dyes	F	-	G	F
Aniline Oils	F	-	F	F
Asphalt	-	-	G	-
Benzine (Gasoline)	-	G	G	-
Bromine	-	-	G	-
Butylene	-	F	G	-
Calcium Hypochlorite (no free Chlorine)	G	-	G	F
Calcium Salt solutions	G	G	G	F
Carbolic Acid (Phenol) RT or Hot	F	-	G	-
Carbon Dioxide (Dry)	G	G	F	F
Carbonic Acid	G	F	G	G
Carbon Disulphide RT	-	-	G	-
Carbon Tetrachloride RT	-	-	G	-
Chlorinated Solvents	-	-	G	G
Chlorine (Dry)	-	-	G	-
Chlorine (wet or solutions)	F	-	G	-
Cottonseed Oil	G	G	G	G
Creosote (wood or coal tar)	-	G	G	-
Chromic Acid 50%	-	F	G	-
Citric Acid	G	G	G	G
Copper Salt Solutions	G	F	G	G
Diesel Fuel	-	G	G	-
Ethers RT	F	F	G	-
Ethylene Glycol	G	G	G	G
Ethylene Dichloride	-	-	G	G
Ferric Salt Solutions	G	G	G	G
Ferrous Salt Solutions	G	G	G	G
Formaldehyde RT	F	-	-	G
Fuel Oil	-	G	F	-
Furfural	G	-	-	-
Freon 12 (Refrigerant)	G	G	G	-
Freon 13 (Refrigerant)	F	G	G	-
Gasoline (Sour or refined)	-	G	G	-
Glycerin (Glycerol)	G	G	G	G
Heptane	-	G	G	-
Hexane	-	G	G	-

FLUID	GASKET MATERIAL			
	D	C/N	V	S
Hydraulic Oils	-	G	G	-
Straight Petroleum Base	-	-	-	-
Water Petroleum Emulsion	-	G	G	F
Water Glycol	G	G	G	F
Straight Phosphate Ester	G	-	F	F
Phosphate Ester/Petroleum Blend	-	-	F	-
Ester Blend	G	G	F	F
Silicone Oils	G	G	G	-
Hydrochloric Acid RT	G	F	G	-
Hydrofluoric Acid (48% sol) RT	-	-	G	-
Hydrolube	G	G	G	F
Hydrogen Peroxide (dilute)	F	F	G	G
Hydrogen Peroxide (concentrated)	-	-	F	F
Hydrogen Sulfide (dry) RT	F	F	-	-
Hydrogen Sulfide (wet) RT	F	-	G	-
Hypochlorite Solutions (no free Chlorine)	G	F	G	F
Kerosene RT	-	G	G	-
Linseed Oil	-	G	G	-
Lube Oil (Mineral)	-	G	G	-
Lubricating Oils (Diester Base)	-	F	G	-
Magnesium Salt Solutions	G	G	G	G
Mercuric Chloride	G	G	G	-
Mercury	G	G	G	F
Mineral Oil	-	G	G	G
Naphtha	-	F	G	-
Napthalene	-	-	G	-
Nitric Acid (less than 20%)	F	-	G	-
Oleic Acid	-	G	F	-
Oxalic Acid	G	F	G	F
Oxygen, Gaseous	G	F	G	G
Paraffin	-	G	G	F
Petroleum Oils (Sour or Refined)	-	G	G	-
Phosphoric Acid (Commercial)	G	-	G	-
Potassium Salt Solutions	G	G	G	G
Pydraul C Series, F	F	-	G	F
Pydraul F Series	G	-	-	-
Sodium Salt solutions	G	G	G	F
Steam	F	-	-	-
Sulfur	G	-	-	-
Sulfur Dioxide (wet or dry)	G	-	-	F
Sulfuric Acid (10-75%)	F	-	G	-
Sulfuric Acid (75-95%)	-	-	G	-
Sulfuric Acid (95%) RT	-	-	G	-
Sulfurous Acid	-	F	G	-
Tannic Acid	F	G	F	F
Trichlorethylene	-	-	G	-
Turpentine	-	F	G	-
Vegetable Oils	G	G	G	G
Water (fresh or salt) cold	G	G	G	G
Water (fresh or salt) hot +215° F. max.	G	!!	G	-
Xylene	-	-	G	-
Zinc Salt Solutions	G	G	G	G

!! C maximum +180° F, N maximum +225° F.

How to order AMER region part numbers

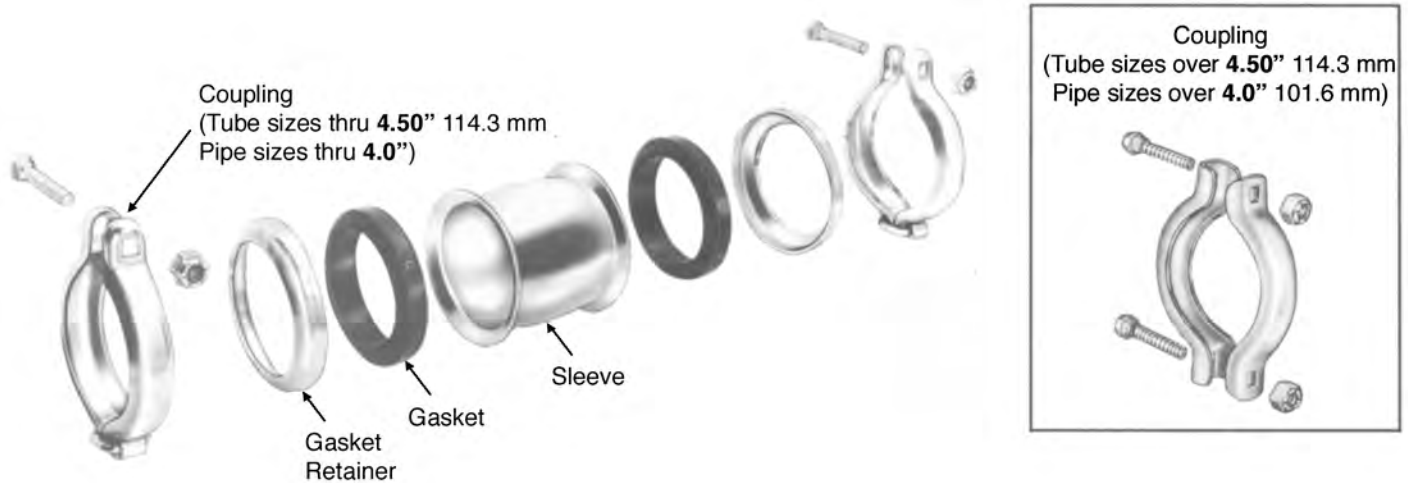

Standard (Un-Restrained) Style



Self-Restrained Style

NH16XX () 000 () 000

<p>Basic Part Number (from pages 18-25)</p> <p>Example: NH1600</p> <p>Gasket Material:</p> <ul style="list-style-type: none"> C = BUNA-N (standard) D = EPDM *N = BUNA-N (high temperature) *S = Silicone *V = Fluorocarbon *G = Mineral Fiber <p>(Exhaust Applications not subject to flexing)</p> <p>* Available in Standard (Un-Restrained) Model Only.</p>	<p>Joint Length (in thousands of inch).</p> <p>Example: 2.5" = 0250</p> <p>Style is available in lengths shown. Other lengths are available in multiples of 1-inch on special requests. Contact Danfoss for availability.</p> <p>Sleeve Material:</p> <ul style="list-style-type: none"> B = Plated Steel (Standard) S = Stainless Steel (Sleeve only-consult Danfoss for availability) <p>Size of Pipe or Tube to be connected (in hundredths of inch) Example: .75" = 075</p>
---	--

Example Part Number: NH1600C075B0250

Complete assemblies may be ordered by the procedure shown above. Standard components may be ordered as shown on page 19.

Technical Data

Parts List

Gasket Material: C – BUNA-N (standard)
 D – EPDM
 N – BUNA-N
 (high temperature)
 V – Fluorocarbon
 S – Silicone
 (Other materials available. Consult Danfoss.)

COUPLING		STRAIGHT SLEEVES	GASKET RETAINER	GASKETS					Self Restrained Gasket	Material Available from Stock				
Tube size (inches)	Tube O.D. (inches)	Includes Nut & Bolt Standard	Standard	Standard	Standard Gasket	C	D*	G	N*	S	V	Gasket	C	D*
1.00	1.00	NH100085-075YF	NK1237-075B0250	NK1000023-075	NK1000064X100	X	X	X	-	X	X	NK1000062X100	X	-
1.25	1.25	NH100085-100YF	NK1237-100B0288	NK1000023-100	NK1000064X125	X	X	-	X	X	X	NK1000062X125	X	X
1.38	1.38	NH100086-150YF	NK1237-138B0300	NK1000056-138	NK1000064X138	X	-	-	-	X	-	NK1000062X138	X	-
1.50	1.50	NH100086-150YF	NK1238-150B0300	NK1000056-150	NK1000064X150	X	X	-	-	X	X	NK1000062X150	X	X
1.75	1.75	NH100085-150YF	NK1238-175B0350	NK1000056-175	NK1000064X175	X	X	-	-	-	-	NK1000062X175	X	-
2.00	2.00	NH100086-200YF	NK1238-200B0350	NK1000056-200	NK1000064X200	X	X	X	-	X	X	NK1000062X200	X	-
2.25	2.25	NH100085-200YF	NK1238-225B0400	NK1000056-225	NK1000064X225	X	X	-	-	-	-	-	-	-
2.50	2.50	NH100086-250YF	NK1238-250B0400	NK1000056-250	NK1000064X250	X	X	-	-	X	X	NK1000062X250	X	X
2.88	2.88	NH100085-250YF	NK1237-250B0650	NK1000023-250	NK1000063X250	X	X	X	-	X	X	NK1000061X250	X	-
3.00	3.00	NH100086-300YF	NK1238-300B0500	NK1000056-300	NK1000064X300	X	X	-	X	X	X	NK1000062X300	X	-
3.25	3.25	NH100086-325YF	NK1238-325B0650	NK1000056-325	NK1000064X325	X	-	-	-	-	-	NK1000062X325	X	-
3.50	3.50	NH100085-300YF	NK1237-300B0650	NK1000023-300	NK1000063X300	X	X	X	X	X	X	NK1000061X300	X	X
4.00	4.00	NH100085-350YF	NK1237-350B0650	NK1000023-350	NK1000063X350	X	X	X	X	X	X	NK1000061X350	X	X
4.50	4.50	NH100085-400YF	NK1237-400B0650	NK1000023-400	NK1000063X400	X	X	-	X	X	X	NK1000061X400	X	X
5.00	5.00	NH100086-500YF	NK1238-500B0650	NK1000056-500	NK1000064X500	X	X	-	-	-	-	NK1000062X500	X	X
Pipe Size (inches)	Pipe O.D. (inches)													
.38	.675	NH100085-038YF	NK1237-038B0200	NK1000023-038	NK1000063X038	X	-	-	-	-	X	-	-	-
.50	.840	NH100085-050YF	NK1237-050B0225	NK1000023-050	NK1000063X050	X	X	-	X	X	X	NK1000061X050	X	-
.75	1.050	NH100085-075YF	NK1237-075B0250	NK1000023-075	NK1000063X075	X	-	X	X	X	X	NK1000061X075	X	-
1.00	1.315	NH100085-100YF	NK1237-100B0288	NK1000023-100	NK1000063X100	X	X	-	X	X	X	NK1000061X100	X	X
1.25	1.660	NH100085-125YF	NK1237-125B0325	NK1000023-125	NK1000063X125	X	X	-	X	X	X	NK1000061X125	X	X
1.50	1.900	NH100085-150YF	NK1237-150B0350	NK1000023-150	NK1000063X150	X	X	-	X	X	X	NK1000061X150	X	X
2.00	2.375	NH100085-200YF	NK1237-200B0400	NK1000023-200	NK1000063X200	X	X	-	X	X	X	NK1000061X200	X	X
2.50	2.875	NH100085-250YF	NK1237-250B0650	NK1000023-250	NK1000063X250	X	X	X	X	X	X	NK1000061X250	X	X
3.00	3.500	NH100085-300YF	NK1237-300B0650	NK1000023-300	NK1000063X300	X	X	X	X	X	X	NK1000061X300	X	X
3.50	4.000	NH100085-350YF	NK1237-B3500650	NK1000023-350	NK1000063X350	X	X	X	X	X	X	NK1000061X350	X	X
4.00	4.500	NH100085-400YF	NK1237-400B0650	NK1000023-400	NK1000063X400	X	X	-	X	X	X	NK1000061X400	X	X
5.00	5.563	NH100085-500YF	NK1237-500B0650	NK1000023-500	NK1000063X500	X	X	-	X	-	X	NK1000061X500	X	-
6.00	6.625	NH100085-600YF	NK1237-600B0650	NK1000023-600	NK1000063X600	X	X	-	X	-	X	NK1000061X600	X	X

*These gasket materials can be ordered in sizes other than those listed. Contact Danfoss for availability.

Bolt Part Numbers

JOINT SIZE (inches)		BOLT PART NUMBER	NUT PART NUMBER
Tube	Pipe	Carbon Steel	Carbon Steel
.50 to 1.12	.38 to .75	56519A4-7	56535A4C-C
1.25 to 2.50	1 to 2	56519A5-8	56535A5C-C
2.75 to 5	2.50 to 4	56519A6-12	56535A6C-C
6	5 to 6	56519A8-16	56535A8C-C

Stainless steel bolting is recommended for replacement where mineral fiber gaskets are used or when high temperatures exist. Contact Danfoss for replacement bolts and nuts on High Temperature Flexmaster joint for +1200° F. (+649° C.)

Technical Data

Table 1. Required insertion depth* of pipe and tube

Pipe Size	"D" min.	"D" max.	Tube Size	"D" min.	"D" max.
.38	.71 18	1.00 25.4	.75 19.1	.74 18.8	1.10 27.9
.50	.71 18	1.09 27.7	.88 22.3	.65 16.5	1.00 25.4
.75	1.00 25.4	1.21 30.7	1.00 25.4	.72 18.3	1.21 30.7
1.00	1.14 29	1.39 35.3	1.12 28.4	.93 23.6	1.21 30.7
1.25	1.15 29.2	1.56 39.6	1.25 31.8	1.16 29.5	1.40 35.6
1.50	1.16 29.5	1.62 41.1	1.38 35.1	1.20 30.5	1.46 37.1
2.00	1.18 30	1.84 46.7	1.50 38.1	1.18 30	1.45 36.8
2.50	1.68 42.7	2.38 60.5	1.75 44.5	1.22 31	1.69 42.9
3.0	1.70 43.2	2.40 61	2.00 50.8	1.15 29.2	1.68 42.7
3.50	1.72 33.7	2.42 61.5	2.25 57.2	1.24 31.5	1.84 46.7
4.00	1.74 44.2	2.44 62	2.38 60.3	1.18 30	1.84 46.7
5.00	2.08 52.8	2.24 56.9	2.50 63.5	1.17 29.7	1.83 46.5
6.00	1.86 47.2	2.33 59.2	2.75 69.9	1.74 44.2	1.90 48.3
			2.88 73.0	1.68 42.7	2.38 60.5
			3.00 76.2	1.67 42.4	2.30 58.4
			3.25 82.6	1.67 42.4	2.48 63
			3.50 88.9	1.70 43.2	2.40 61
			4.00 101.6	1.72 33.7	2.42 61.5
			4.50 114.3	1.74 44.2	2.44 62
			5.00 127	1.75 44.5	2.07 52.6

*Dimensions shown are for standard, straight, bulged sleeves only. Elbow, tees and specials must meet the minimum insertion depths.
NOTE: **inches and inch-lbs in bold**, mm and N•m in light.

Table 2. Flexmaster joint assembly tightening guide. Torque Method of installation**

Size	Standard	Self-Restrained
.75" to 1.12" Tube (19.1 to 28.4 mm)	40-60 inch-lbs. (4.55-6.88 N•m)	40-60 inch-lbs. (4.55-6.88 N•m)
.38" to .75" Pipe		
1.25" to 2.75" Tube (31.8 to 69.9 mm)	90-100 inch-lbs. (10.14-12.39 N•m)	140-160 inch-lbs. (15.78-18.13 N•m)
1" to 2" Pipe		
2.88" to 3.50" Tube (73 to 88.9 mm)	180-200 inch-lbs. (20.27-22.52 N•m)	220-240 inch-lbs. (24.79-27.14 N•m)
2.50" to 3" Pipe		
4" to 5" Tube (101.6 to 127 mm)	240-260 inch-lbs. (27.14-29.28 N•m)	280-300 inch-lbs. (31.53-33.8 N•m)
3.50" to 4" Pipe		
6" Tube (152.4 mm)	300-360 inch-lbs. (33.8-36.15 N•m)	480-500 inch-lbs. (54.05-56.42 N•m)
5" to 6" Pipe		

**Note: the torque values specified are for an un-lubricated (dry) nut and bolt.

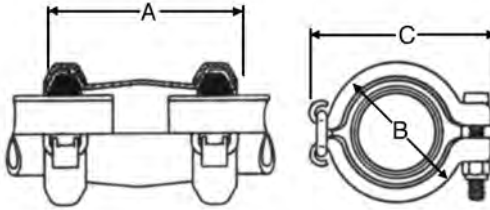

Table 3. Optional Clearance Method for Installation of Standard Gaskets.

(Self-restrained gaskets must be installed by Torque Method.)

Tube Size	Pipe Size	Dimension X ±.06
		1.5
.50, .63, .75 12.7, 16.0, 19.1	³ / ₈ , 1/2	.62 15.8
1.00, 1.13 25.4, 28.7	³ / ₄	.69 17.5
1.25, 1.38 31.8, 35.1	1	.94 23.9
1.50, 1.75 38.1, 44.5	1 1/4	.94 23.9
	1 1/2	.94 23.9
2.25 57.2	2	.88 22.4
2.50, 2.75 63.5, 69.9	2 1/2	1.50 38.1
3.00, 3.25 76.2, 82.6	3	1.56 39.6
	3 1/2	1.56 39.6
	4	1.56 39.6
5.00, 6.00 127, 152.4	5, 6	Use Torque Method

Joists for Rigid Pipe



Basic Part Number: NH1600
NH1650
Allowable misalignment: $\pm 4^\circ$ per end

PIPE SIZE	PIPE O.D.	B	C	STRAIGHT PART NUMBER*	A
.38	.675	1.48	2.34	**NH1600X038X0200	2.00
	17.1	37.6	59.4	-	50.8
.50	.840	1.65	2.53	NH1600X050X0225	2.25
	21.3	41.9	64.3	NH1650X050X0225	57.2
.75	1.050	1.86	2.75	NH1600X075X0250	2.50
	26.7	47.2	69.9	NH1650X075X0250	63.5
1.00	1.315	2.37	3.48	NH1600X100X0288	2.88
	33.4	60.2	88.4	NH1650X100X0288	73.2
1.25	1.660	2.71	3.85	NH1600X125X0325	3.25
	42.2	68.8	97.8	NH1650X125X0325	82.6
1.50	1.900	2.96	4.11	NH1600X150X0350	3.50
	48.3	75.2	104.4	NH1650X150X0350	88.9
2.00	2.375	3.43	4.60	NH1600X200X0400	4.00
	60.3	87.1	116.8	NH1650X200X0400	101.6
2.50	2.875	4.73	6.23	NH1600X250X0650	6.50
	73.0	120.1	158.2	NH1650X250X0650	165.1
3.00	3.500	5.36	6.87	NH1600X300X0650	6.50
	88.9	136.1	174.5	NH1650X300X0650	165.1
3.50	4.000	5.86	7.38	NH1600X350X0650	6.50
	101.6	148.8	187.5	NH1650X350X0650	165.1
4.00	4.500	6.36	7.89	NH1600X400X0650	6.50
	114.3	161.5	200.5	NH1650X400X0650	165.1
5.00	5.563	8.22	10.62	**NH1600X500X0650	6.50
	141.4	208.8	269.7	NH1650X500X0650	165.1
6.00	6.625	8.86	11.24	**NH1600X600X0650	6.50
	168.3	225.0	285.5	NH1650X600X0650	165.1

Note: Letter X in part numbers shown indicates a code letter to be filled in. See Page 15 for explanation of part numbers and how to order.

* Gray part numbers are standard type. Black part numbers are self-restrained type.

** Sleeve in this size is cylindrical (no-bulge). Allowable misalignment is $\pm 2^\circ$ per end for this size.

Dimensions: **inches in bold**, mm in light

Joins for Rigid Pipe

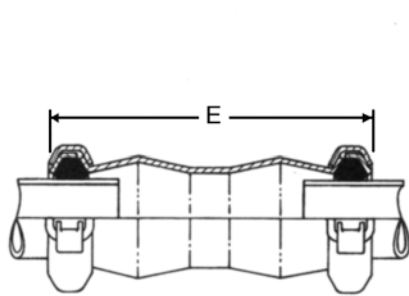

Basic Part Number: NH1600 (Long)
NH1650 (Long)
Allowable misalignment: $\pm 4^\circ$ per end

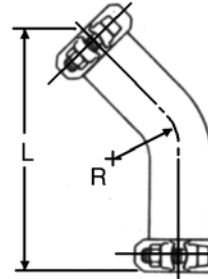

Basic Part Number: NH1601
NH1651
Allowable misalignment: $\pm 2^\circ$ per end

PIPE SIZE	PIPE O.D.	STRAIGHT DOUBLE-BULGED	E†	45° LONG ELBOW	L	R
		PART NUMBER*		PART NUMBER*		
.38	.675	**NH1600X038X0200	2.00	NH1601X038X	4.16	.88
	17.1	-	50.8	-	105.7	22.3
.50	.840	NH1600X050X0350	3.50	NH1601X050X	4.37	1.06
	21.3	NH1650X050X0350	88.9	NH1651X050X	111.0	26.9
.75	1.050	NH1600X075X0400	4.00	NH1601X075X	5.33	1.31
	26.7	NH1650X075X0400	101.6	NH1651X075X	135.4	34.3
1.00	1.315	NH1600X100X0450	4.50	NH1601X100X	5.77	1.62
	33.4	NH1650X100X0450	114.3	NH1651X100X	146.6	41.1
1.25	1.66	NH1600X125X0550	5.50	NH1601X125X	5.97	1.88
	42.2	NH1650X125X0550	139.7	NH1651X125X	151.6	47.8
1.50	1.900	NH1600X150X0575	5.75	NH1601X150X	6.18	2.12
	48.3	NH1650X150X0575	146.1	NH1651X150X	157.0	53.8
2.00	2.375	NH1600X200X0675	6.75	NH1601X200X	6.40	2.62
	60.3	NH1650X200X0675	171.5	NH1651X200X	162.6	66.5
2.50	2.875	NH1600X250X1125	11.25	NH1601X250X	7.26	3.25
	73.0	NH1650X250X1125	285.8	NH1651X250X	184.3	82.6
3.00	3.500	NH1600X300X1125	11.25	NH1601X300X	8.54	5.00
	88.9	NH1650X300X1125	285.8	NH1651X300X	216.9	127.0
3.50	4.000	NH1600X350X1125	11.25	NH1601X350X	9.18	6.00
	101.6	NH1650X350X1125	285.8	NH1651X350X	233.1	152.4
4.00	4.500	NH1600X400X1125	11.25	NH1601X400X	9.82	7.00
	114.3	NH1650X400X1125	285.8	NH1651X400X	249.4	177.8
5.00	5.563	NH1600X500X0650	6.50			
	141.4	NH1650X500X0650	165.1			
6.00	6.625	NH1600X600X0650	6.50			
	168.3	NH1650X600X0650	165.1			

Note: Letter X in part numbers shown indicates a code letter to be filled in. See Page 15 for explanation of part numbers and how to order.

*Gray part numbers are standard type. Black part numbers are self-restrained type.

** Sleeve in this size is cylindrical (no-bulge). Allowable misalignment is $\pm 2^\circ$ per end for this size.

† Straight, Double-Bulged joints are available in longer lengths than "E" shown in increments of 1 inch. Consult Danfoss. "E" dimension is minimum length for longer joints

Dimensions: **inches in bold**, mm in light.

Joists for Rigid Pipe

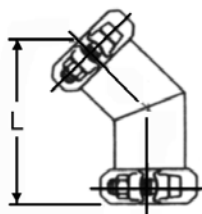

Basic part number: NH1617
NH1667
Allowable misalignment: $\pm 2^\circ$ per end

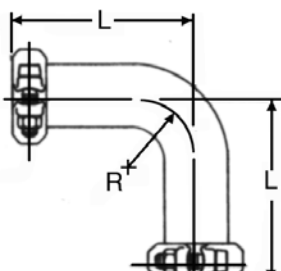

Basic Part Number: NH1602
NH1652
Allowable misalignment: $\pm 2^\circ$ per end

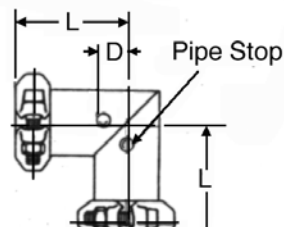

Basic Part Number: NH1618
NH1668
Allowable misalignment: $\pm 2^\circ$ per end

PIPE SIZE	45° SHORT ELBOW PART NUMBER*		90° LONG ELBOW PART NUMBER*			90° SHORT ELBOW PART NUMBER*		
		L		L	R		L	D
.38	NH1617X038X	2.56	NH1602X038X	2.44	.88	NH1618X038X	1.88	.38
	-	65.0	-	62.0	22.3	-	47.8	9.7
.50	NH1617X050X	2.99	NH1602X050X	2.56	1.06	NH1618X050X	2.03	.46
	NH1667X050X	75.9	NH1652X050X	65.0	26.9	NH1668X050X	51.6	10.7
.75	NH1617X075X	3.41	NH1602X075X	3.88	1.31	NH1618X075X	2.31	.56
	NH1667X075X	86.6	NH1652X075X	98.6	34.3	NH1668X075X	58.7	14.2
1.00	NH1617X100X	3.89	NH1602X100X	4.25	1.62	NH1618X100X	2.69	.72
	NH1667X100X	98.8	NH1652X100X	108.0	41.1	NH1668X100X	68.3	18.3
1.25	NH1617X125X	4.42	NH1602X125X	4.50	1.88	NH1618X125X	3.09	.88
	NH1667X125X	112.3	NH1652X125X	114.3	47.8	NH1668X125X	78.5	22.3
1.50	NH1617X150X	4.85	NH1602X150X	4.88	2.12	NH1618X150X	3.41	1.00
	NH1667X150X	123.2	NH1652X150X	124.0	53.8	NH1668X150X	86.6	25.4
2.00	NH1617X200X	5.55	NH1602X200X	5.38	2.62	NH1618X200X	3.97	1.25
	NH1667X200X	141.0	NH1652X200X	136.7	66.5	NH1668X200X	100.8	31.8
2.50	NH1617X250X	5.97	NH1602X250X	6.12	3.25	NH1618X250X	4.62	1.56
	NH1667X250X	151.6	NH1652X250X	155.4	82.6	NH1668X250X	117.3	39.6
3.00	NH1617X300X	6.40	NH1602X300X	8.06	5.00	NH1618X300X	5.00	1.88
	NH1667X300X	162.6	NH1652X300X	204.7	127.0	NH1668X300X	127.0	47.8
3.50	NH1617X350X	6.83	NH1602X350X	9.06	6.00	NH1618X350X	52.5	2.19
	NH1667X350X	173.5	NH1652X350X	230.1	152.4	NH1668X350X	133.4	55.6
4.00	NH1617X400X	7.26	NH1602X400X	10.06	7.00	NH1618X400X	5.50	2.44
	NH1667X400X	184.4	NH1652X400X	255.5	177.8	NH1668X400X	139.7	62.0

Note: Letter X in part numbers shown indicates a code letter to be filled in.
See Page 15 for explanation of part numbers and how to order.

*Gray part numbers are standard type. Black part numbers are self-restrained type.

Dimensions: **inches in bold**, mm in light

Joists for Rigid Pipe

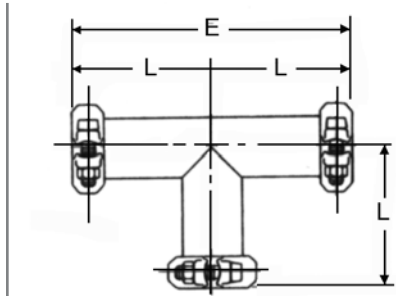

Basic Part Number: NH1604
NH1654
Allowable misalignment: $\pm 2^\circ$ per end

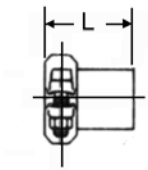

Basic Part Number NH1606
NH1656
Allowable misalignment: $\pm 2^\circ$ per end

PIPE SIZE	TEE PART NUMBER*	L	E	BULKHEAD JOINT PART NUMBER*	MIN. L
.38	NH1604X038X	2.25	4.50	NH1606X038X	1.75
	-	57.2	114.3	-	45.1
.50	NH1604X050X	2.50	5.00	NH1606X050X	1.75
	NH1654X050X	63.5	127.0	NH1656X050X	45.1
.75	NH1604X075X	2.88	5.76	NH1606X075X	2.25
	NH1654X075X	73.5	146.3	NH1656X075X	57.2
1.00	NH1604X100X	3.50	7.00	NH1606X100X	2.50
	NH1654X100X	88.9	177.8	NH1656X100X	63.5
1.25	NH1604X125X	4.12	8.24	NH1606X125X	2.62
	NH1654X125X	104.6	209.3	NH1656X125X	66.5
1.50	NH1604X150X	4.50	9.00	NH1606X150X	2.88
	NH1654X150X	114.3	228.6	NH1656X150X	73.2
2.00	NH1604X200X	5.25	10.50	NH1606X200X	3.38
	NH1654X200X	133.4	266.7	NH1656X200X	85.9
2.50	NH1604X250X	6.94	13.88	NH1606X250X	4.00
	NH1654X250X	176.3	352.6	NH1656X250X	101.6
3.00	NH1604X300X	7.94	15.88	NH1606X300X	4.00
	NH1654X300X	201.7	403.4	NH1656X300X	101.6
3.50	NH1604X350X	8.69	17.38	NH1606X350X	4.00
	NH1654X350X	220.7	441.5	NH1656X350X	101.6
4.00	NH1604X400X	9.44	18.88	NH1606X400X	4.00
	NH1654X400X	239.8	479.6	NH1656X400X	101.6

Note: Letter X in part numbers shown indicates a code letter to be filled in.

See Page 15 for explanation of part numbers and how to order.

*Gray part numbers are standard type. Black part numbers are self-restrained type.

Dimensions: **inches in bold**, mm in light

Joins for Inch-Size Tube

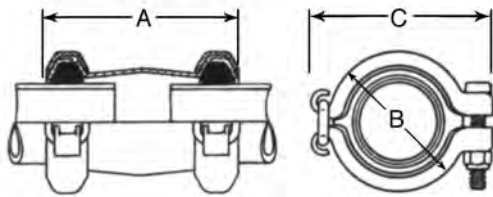

Basic part number: NH1625
NH1675
Allowable misalignment: ±4° per end

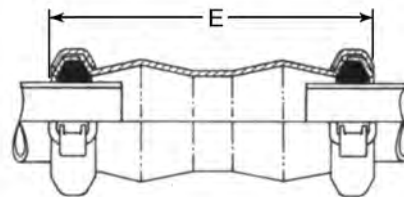

Basic Part Number NH1625 (Long)
NH1675 (Long)
Allowable misalignment: ±2° per end

TUBE SIZE	B	C	STRAIGHT PART NUMBER*	A	STRAIGHT DOUBLE-BULGED PART NUMBER*	Et
.75 19.1	1.65 41.9	2.53 64.3	NH1625X075X0225 -	2.25 57.2	NH1625X075X0350 -	3.50 88.9
.88 22.2	1.65 41.9	2.53 64.3	NH1625X088X0225 -	2.25 57.2	NH1625X088X0350 -	3.50 88.9
1.00 25.4	1.86 47.2	2.75 69.9	NH1625X100X0250 NH1675X100X0250	2.50 63.5	NH1625X100X0400 NH1675X100X0400	4.00 101.6
1.12 28.6	1.86 47.2	2.75 69.9	NH1625X112X0250 -	2.50 63.5	NH1625X112X0450 -	4.50 114.3
1.25 31.8	2.37 60.2	3.48 88.4	NH1625X125X0288 NH1675X125X0288	2.88 73.2	NH1625X125X0450 NH1675X125X0450	4.50 114.3
1.38 34.9	2.55 64.8	3.68 93.5	NH1625X138X0300 NH1675X138X0300	3.00 76.2	NH1625X138X0475 NH1675X138X0475	4.75 120.7
1.50 38.1	2.55 64.8	3.68 93.5	NH1625X150X0300 NH1675X150X0300	3.00 76.2	NH1625X150X0475 NH1675X150X0475	4.75 120.7
1.75 44.5	2.96 75.2	4.11 104.4	NH1625X175X0350 NH1675X175X0350	3.50 88.9	NH1625X175X0575 NH1675X175X0575	5.75 146.1
2.00 50.8	3.06 77.7	4.20 106.7	NH1625X200X0350 NH1675X200X0350	3.50 88.9	NH1625X200X0575 NH1675X200X0575	5.75 146.1
2.25 54.9	3.43 87.1	4.60 116.8	NH1625X225X0400 -	4.00 101.6	NH1625X225X0675 -	6.75 171.5
2.38 60.3	3.43 87.1	4.60 116.8	NH1600X200X0400 NH1650X200X0400	4.00 101.6	NH1600X200X0675 NH1650X200X0675	6.75 171.5
2.50 63.5	3.55 90.2	4.72 133.9	NH1625X250X0400 NH1675X250X0400	4.00 101.6	NH1625X250X0675 NH1675X250X0675	6.75 171.5
2.75 69.9	4.73 120.1	6.23 158.2	NH1625X275X0400 -	4.00 101.6	NH1625X275X0675 -	6.75 171.5
2.88 73.0	4.73 120.1	6.23 158.2	NH1600X250X0650 NH1650X250X0650	6.50 165.1	NH1600X250X1125 NH1650X250X1125	11.25 285.8
3.00 76.2	4.86 123.4	6.34 161.0	NH1625X300X0500 NH1675X300X0500	5.00 127.0	NH1625X300X1125 NH1675X300X1125	11.25 285.8
3.25 86.6	5.11 129.8	6.60 167.7	NH1625X325X0650 -	6.50 165.1	NH1625X325X1125 -	11.25 285.8
3.50 88.9	5.36 136.1	6.87 174.5	NH1600X300X0650 NH1650X300X0650	6.50 165.1	NH1600X300X1125 NH1650X300X1125	11.25 285.8
4.00 101.6	5.86 148.8	7.38 187.5	NH1600X350X0650 NH1650X350X0650	6.50 165.1	NH1600X350X1125 NH1650X350X1125	11.25 285.8
4.50 114.3	6.36 161.5	7.89 200.5	NH1600X400X0650 NH1650X400X0650	6.50 165.1	NH1600X400X1125 NH1650X400X1125	11.25 285.8
5.00 127.0	6.86 174.2	8.76 222.5	**NH1625X500X0650 NH1675X500X0450	6.50 165.1	**NH1625X500X0650 NH1675X500X0450	6.50 165.1

Note: Letter X in part numbers shown indicates a code letter to be filled in.
See Page 15 for explanation of part numbers and how to order.

*Gray part numbers are standard type. Black part numbers are self-restrained type.

Dimensions: **inches in bold**, mm in light

**Sleeve in this size is cylindrical (unbulged). Allowable misalignment for this size is ±2° per end.

† Straight, Double-Bulged joints are available in longer lengths than "E" shown in increments of 1 inch. "E" dimension is **minimum length** for longer joints.

Joins for Inch-Size Tube

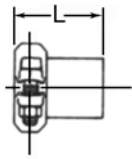

Basic part number: **NH1631**
NH1681
 Allowable misalignment: $\pm 2^\circ$ per end

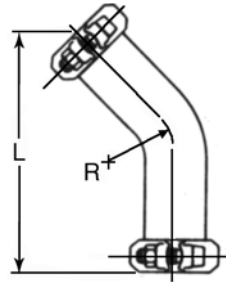

Basic Part Number **NH1626 (Long)**
NH1676 (Long)
 Allowable misalignment: $\pm 2^\circ$ per end

TUBE SIZE	BULKHEAD JOINT PART NUMBER*	MIN. L	45° ELBOW PART NUMBER*	L	R
.75	-	-	-	-	-
19.1	-	-	-	-	-
.88	-	-	-	-	-
22.2	-	-	-	-	-
1.00	NH1631X100X	2.25	NH1626X100X	5.33	1.31
25.4	NH1681X100X	57.2	NH1676X100X	140.5	34.3
1.12	-	-	-	-	-
28.6	-	-	-	-	-
1.25	NH1631X125X	2.50	NH1626X125X	5.77	1.62
31.8	NH1681X125X	6.35	NH1676X125X	146.6	41.1
1.38	NH1631X138X	2.62	NH1626X138X	5.97	1.75
34.9	NH1681X138X	6.65	NH1676X138X	151.6	44.5
1.50	NH1631X150X	2.62	NH1626X150X	5.97	1.75
38.1	NH1681X150X	6.65	NH1676X150X	151.6	44.5
1.75	-	-	-	-	-
44.5	-	-	-	-	-
2.00	NH1631X200X	2.88	NH1626X200X	6.30	2.25
50.8	NH1681X200X	73.2	NH1676X200X	160.0	57.2
2.25	-	-	-	-	-
54.9	-	-	-	-	-
2.38	-	-	-	-	-
60.3	-	-	-	-	-
2.50	NH1631X250X	3.38	NH1626X250X	6.62	2.75
63.5	NH1681X250X	85.9	NH1676X250X	168.1	69.9
2.75	-	-	-	-	-
69.9	-	-	-	-	-
2.88	-	-	-	-	-
73.0	-	-	-	-	-
3.00	NH1631X300X	4.00	NH1626X300X	7.68	3.38
76.2	NH1681X300X	101.6	NH1676X300X	195.1	85.9
3.25	-	-	-	-	-
86.6	-	-	-	-	-
3.50	NH1606X300X	4.00	NH1601X300X	8.54	5.00
88.9	NH1656X300X	101.6	NH1651X300X	216.9	127.0
4.00	NH1606X350X	4.00	NH1601X350X	9.18	6.00
101.6	NH1656X350X	101.6	NH1651X350X	233.1	152.4
4.50	NH1606X400X	4.00	NH1601X400X	9.82	7.00
114.3	NH1656X400X	101.6	NH1651X400X	249.4	177.8
5.00	NH1631X500X	4.00	-	-	-
127.0	NH1681X500X	101.6	-	-	-

Dimensions: **inches in bold**, mm in light

Note: Letter X in part numbers shown indicates a code letter to be filled in.

See Page 15 for explanation of part numbers and how to order.

*Gray part numbers are standard type. Black part numbers are self-restrained type.

Joins for Inch-Size Tube

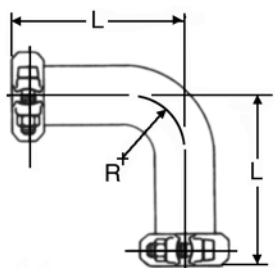

Basic part number: **NH1627**
NH1677
 Allowable misalignment: $\pm 2^\circ$ per end

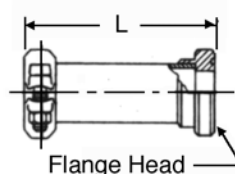

Basic Part Number **NH1635**
NH1685
 Allowable misalignment: $\pm 2^\circ$ per end

TUBE SIZE	90° ELBOW PART NUMBER*	L	R	SAE FLANGE HEAD SIZE	STRAIGHT PART NUMBER*	L
.75 19.1	NH1627X075X -	2.62 66.5	1.06 26.9	- -	- -	- -
1.00 25.4	NH1627X100X NH1677X100X	3.88 98.6	1.31 34.3	1.00 25.4	NH1635X100 NH1685X100	3.56 90.4
- -	- -	- -	- -	1.25 31.8	NH1635X100-125 NH1685X100-125	3.56 90.4
1.25 31.8	NH1627X125X NH1677X125X	4.25 108.0	- -	1.25 31.8	NH1635X125 NH1685X125	3.69 93.7
- -	- -	- -	- -	1.50 38.1	NH1635X125-150 NH1685X125-150	3.75 95.3
1.38 34.9	NH1627X138X NH1677X138X	4.50 114.3	1.75 44.5	1.25 31.8	NH1635X138-125 NH1685X138-125	3.69 93.7
1.50 38.1	NH1627X150X NH1677X150X	4.50 114.3	1.75 44.5	1.50 38.1	NH1635X150 NH1685X150	3.75 95.3
- -	- -	- -	- -	2.00 50.8	NH1635X150-200 NH1685X150-200	3.75 95.3
1.75 44.5	NH1627X175X NH1677X175X	5.00 127.0	2.25 54.9	- -	- -	- -
2.00 50.8	NH1627X200X NH1677X200X	5.00 127.0	2.25 54.9	2.00 50.8	NH1635X200 NH1685X200	4.25 108.0
- -	- -	- -	- -	2.50 63.5	NH1635X200-250 NH1685X200-250	4.31 109.5
2.50 63.5	NH1627X250X NH1677X250X	5.62 142.7	2.75 69.9	2.50 63.5	NH1635X250 NH1685X250	4.31 109.5
- -	- -	- -	- -	- -	NH1635X250-300 NH1685X250-300	4.38 111.3
3.00 76.2	NH1627X300X NH1677X300X	6.44 164.6	3.38 85.9	3.00 76.2	NH1635X300 NH1685X300	4.75 120.7
3.50 88.9	NH1627X350X NH1677X350X	8.06 104.7	5.00 127.0	- -	- -	- -
4.00 101.6	NH1627X400X NH1677X400X	9.06 130.1	6.00 152.4	4.00 101.6	NH1635X400 NH1685X400	5.87 149.1
4.50 114.3	NH1627X450X NH1677X450X	10.6 155.5	7.00 177.8	- -	- -	- -

Dimensions: **inches in bold**, mm in light

Note: Letter X in part numbers shown indicates a code letter to be filled in. See Page 15 for explanation of part numbers and how to order.

*Gray part numbers are standard type. Black part numbers are self-restrained type.

Flexmaster flanged and threaded styles shown on this page are not normally stock items and are not available in stainless steel. Consult Danfoss for delivery.

Joins for Inch-Size Tube

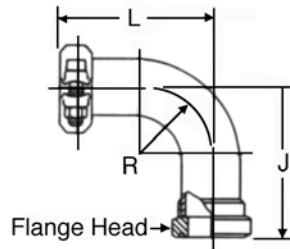

Basic part number: **NH1637**
NH1687
 Allowable misalignment: $\pm 2^\circ$ per end

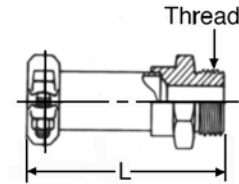

Basic Part Number **NH1641**
NH1691
 Allowable misalignment: $\pm 2^\circ$ per end

TUBE SIZE	90° ELBOW PART NUMBER*	L	J	R	THREAD NPTF	STRAIGHT PART NUMBER*	L
1.00	NH1637X100	3.88	2.38	1.31	1-11 1/2	NH1641X100	3.28
25.4	NH1687X100	98.6	60.5	33.3	-	NH1691X100	83.3
-	NH1637X100-125	3.88	2.38	1.31	-	-	-
-	NH1687X100-125	98.6	60.5	33.3	-	-	-
1.25	NH1637X125	4.25	2.50	1.62	1 1/4 - 11 1/2	NH1641X125	3.62
31.8	NH1687X125	108.0	63.5	41.1	-	NH1691X125	91.9
-	NH1637X125-150	4.25	2.56	16.2	-	-	-
-	NH1687X125-150	108.0	65.0	41.1	-	-	-
1.38	-	-	-	-	-	-	-
34.9	-	-	-	-	-	-	-
1.50	NH1637X150	4.50	2.75	1.75	1 1/2 - 11 1/2	NH1641X150	3.78
38.1	NH1687X150	113.9	69.9	44.5	-	NH1691X150	96.0
-	NH1637X150-200	4.50	2.75	1.75	-	-	-
-	NH1687X150-200	113.9	69.9	44.5	-	-	-
2.00	NH1637X200	5.12	3.25	2.25	-	NH1641X200	4.06
50.8	NH1687X200	130.0	82.6	57.2	-	NH1691X200	103.1
-	NH1637X200-250	5.12	3.31	2.25	-	-	-
-	NH1687X200-250	130.0	85.1	57.2	-	-	-
2.50	NH1637X250	5.62	3.75	2.75	2 1/2 - 8	NH1641X250	4.30
63.5	NH1687X250	142.7	95.3	69.9	-	NH1691X250	109.2
-	NH1637X250-300	5.62	3.81	2.75	-	-	-
-	NH1687X250-300	142.7	96.8	69.9	-	-	-
3.00	NH1637X300	6.50	4.25	3.38	-	-	-
76.2	NH1687X300	165.1	108.0	85.9	-	-	-
3.50	-	-	-	-	-	-	-
88.9	-	-	-	-	-	-	-
4.00	NH1637X400	9.06	7.50	6.00	-	-	-
101.6	NH1687X400	130.1	190.5	152.4	-	-	-
4.50	-	-	-	-	-	-	-
114.3	-	-	-	-	-	-	-

Dimensions: **inches in bold**, mm in light

Note: Letter X in part numbers shown indicates a code letter to be filled in. See Page 15 for explanation of part numbers and how to order.

*Gray part numbers are standard type. Black part numbers are self-restrained type.

Flexmaster flanged and threaded styles shown on this page are not normally stock items and are not available in stainless steel. Consult Danfoss for delivery.



Technical data for EMEA part designs

Alignment errors, absorption of movement

If an alignment error (V) of the pipes to be connected is present, the Flexmaster sleeve must not touch the pipe ends. The permissible alignment error is determined by the insertion depth of the pipe ends (g) and the permissible angle of $\pm 2^\circ$ (see illustration and graph).

All sizes of Flexmaster are designed in such a way as to allow an alignment error of $\pm 2^\circ$. However, if this is exceeded, an appropriately longer Flexmaster sleeve must be selected. This must also be done in cases where pipes in intrinsically correct alignment could be misaligned by vibration.

The illustration opposite shows how to determine the Flexmaster length "L" in relation to "V1" and "V2" while maintaining an angle of $\pm 2^\circ$.

Straight designs of Flexmaster are available up to a maximum length "L" of 1000 mm. If a total length of more than 1000 mm is essential, please use 2 Flexmaster connectors with an intermediate pipe section. This intermediate pipe section must be supported.

The pipes to be used must have wall thicknesses at least equal to those listed opposite to ensure that they are not deformed by any movements which occur.

The pipe ends must have a smooth surface at least at the seal seats in order to ensure correct operation.

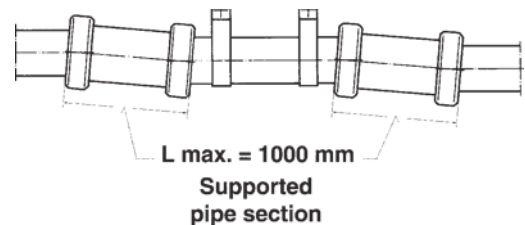
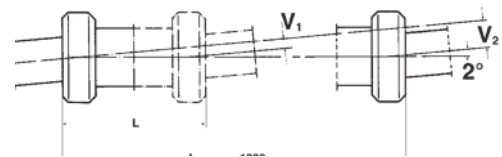
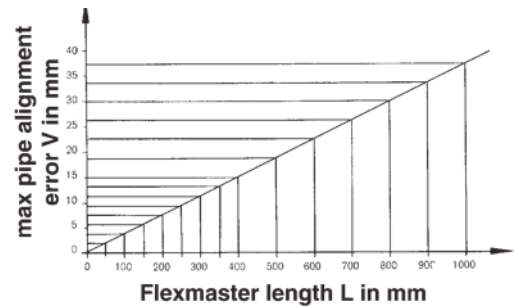
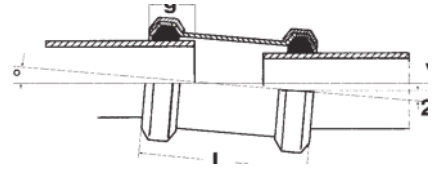

Ext. pipe dia. Ø	Wall thickness
12- 25 mm	1,0 mm
18-120 mm	1,5 mm

Flexmaster, straight

Pipe dia. R acc. to DIN		FLEXMASTER, complete with NBR seal		FLEXMASTER, complete with FPM seal		Dimensions in mm						Weight approx. [kg]		
2391	2441	Part No.	DB Code	Part No.	DB Code	b	C	e	E		g	h	L	
2448	2442								min.	max.				
18		GM10002-018	F-18P/57	GM10202-018	F-18V/57	74	43	43	2	5	20	14,4	57	0.230
20	1/2"	GM10002-020	F-20P/57	GM10202-020	F-20V/57	74	43	43	2	5	20	14,4	57	
21,3		GM10002-8	F-1/2P/57	GM10202-8	F-1/2V/57	74	43	43	2	5	20	14,4	57	
22		GM10002-022	F-22P/57	GM10202-022	F-22V/57	74	43	43	2	5	20	14,4	57	
24		GM10003-024	F-24P/64	GM10203-024	F-24V/64	81	49	46	2	5	20	14,4	64	0.280
25	3/4"	GM10003-025	F-25P/64	GM10203-025	F-25V/64	81	49	46	2	5	20	14,4	64	
26,9		GM10003-12	F-3/4P/64	GM10203-12	F-3/4V/64	81	49	46	2	5	20	14,4	64	
28		GM10004-028	F-28P/73	GM10204-028	F-28V/73	101	62	57	4	8	25	17,7	73	0.470
30	1"	GM10004-030	F-30P/73	GM10204-030	F-30V/73	101	62	57	4	8	25	17,7	73	
32		GM10004-032	F-32P/73	GM10204-032	F-32V/73	101	62	57	4	8	25	17,7	73	
33,7		GM10004-16	F-1P/73	GM10204-16	F-1V/73	101	62	57	4	8	25	17,7	73	
35		GM10005-035	F-35P/76	GM10205-035	F-35V/76	106	67	60	4	8	25	17,7	76	0.560
38		GM10006-038	F-38P/83	GM10206-038	F-38V/83	112	71	63	4	8	25	17,7	83	0.800
40	1 1/4"	GM10006-040	F-40P/83	GM10206-040	F-40V/83	112	71	63	4	8	25	17,7	83	
42		GM10006-042	F-42P/83	GM10206-042	F-42V/83	112	71	63	4	8	25	17,7	83	
42,4		GM10006-20	F-11/4P/83	GM10206-20	F-11/4V/83	112	71	63	4	8	25	17,7	83	
45		GM10007-045	F-45P/89	GM10207-045	F-45V/89	118	77	65	4	8	25	17,7	89	0.640
48,2	1 1/2"	GM10007-24	F-11/2P/89	GM10207-24	F-11/2V/89	118	77	65	4	8	25	17,7	89	
50		GM10008-050	F-50P/89	GM10208-050	F-50V/89	120	80	67	4	8	25	17,7	89	0.670
51		GM10008-32	F-T2P/89	GM10208-32	F-T2V/89	120	80	67	4	8	25	17,7	89	

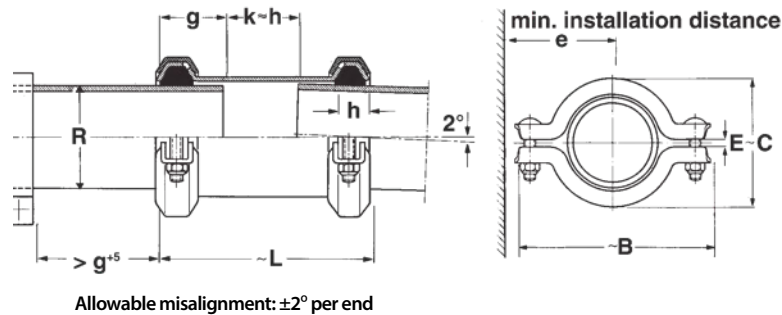

Flexmaster Individual Components

1 Sleeve		2 Seal				3 Seal retainer		4 Clamp complete with bolts	
		NBR		FPM					
Part No.	DB Code	Part No.	DB Code	Part No.	DB Code	Part No.	DB Code	Part No.	DB Code
GM90002-8	H18-22/57=1/2	GM90210-018	P18	GM90208-018	V18	GM90206-8	D18-22=1/2	GM90203-8	S18-22=1/2
GM90002-8	H18-22/57=1/2	GM90210-020	P20	GM90208-020	V20	GM90206-8	D18-22=1/2	GM90203-8	S18-22=1/2
GM90002-8	H18-22/57=1/2	GM90210-8	P1/2	GM90208-8	V 1/2	GM90206-8	D18-22=1/2	GM90203-8	S18-22=1/2
GM90002-8	H18-22/57=1/2	GM90210-022	P22	GM90208-022	V22	GM90206-8	D18-22=1/2	GM90203-8	S18-22=1/2
GM90003-12	H24-26/64=3/4	GM90210-024	P24			GM90206-12	D24-26=3/4	GM90203-12	S24-26=3/4
GM90003-12	H24-26/64=3/4	GM90210-025	P25	GM90208-025	V25	GM90206-12	D24-26=3/4	GM90203-12	S24-26=3/4
GM90003-12	H24-26/64=3/4	GM90210-12	P3/4	GM90208-12	V3/4	GM90206-12	D24-26=3/4	GM90203-12	S24-26=3/4
GM90004-16	H28-32/73=1	GM90210-028	P28	GM90208-028	V28	GM90206-16	D28-32=1	GM90203-16	S28-32=1
GM90004-16	H28-32/73=1	GM90210-030	P30	GM90208-030	V30	GM90206-16	D28-32=1	GM90203-16	S28-32=1
GM90004-16	H28-32/73=1	GM90210-032	P32			GM90206-16	D28-32=1	GM90203-16	S28-32=1
GM90004-16	H28-32/73=1	GM90210-16	P1	GM90208-16	V1	GM90206-16	D28-32=1	GM90203-16	S28-32=1
GM90005-22	H35/76=T1 ³ /8	GM90211-22	P35=T1 ³ /8	GM90209-22	V35=T1 ³ /8	GM90207-22	D35=T1 ³ /8	GM90204-22	S35=T1 ³ /8
GM90006-20	H37-42/83=1 ¹ /4	GM90210-038	P38	GM90208-038	V38	GM90206-20	D37-42=1 ¹ /4	GM90203-20	S37-42=1 ¹ /4
GM90006-20	H37-42/83=1 ¹ /4	GM90210-040	P40			GM90206-20	D37-42=1 ¹ /4	GM90203-20	S37-42=1 ¹ /4
GM90006-20	H37-42/83=1 ¹ /4	GM90210-20	P42=1 ¹ /4			GM90206-20	D37-42=1 ¹ /4	GM90203-20	S37-42=1 ¹ /4
GM90006-20	H37-42/83=1 ¹ /4	GM90210-20	P42=1 ¹ /4			GM90206-20	D37-42=1 ¹ /4	GM90203-20	S37-42=1 ¹ /4
GM90007-24	H45/89=1 ¹ /2	GM90210-045	P45	GM90208-045	V45	GM90206-24	D45=1 ¹ /2	GM90203-24	S45=1 ¹ /2
GM90007-24	H45/89=1 ¹ /2	GM90210-24	P1 ¹ /2			GM90206-24	D45=1 ¹ /2	GM90203-24	S45=1 ¹ /2
GM90008-32	H50/89=T2	GM90211-050	P50	GM90209-050	V50	GM90207-32	D50=T2	GM90204-32	S50=T2
GM90008-32	H50/89=T2	GM90211-32	PT2	GM90209-32	VT2	GM90207-32	D50=T2	GM90204-32	S50=T2

Flexmaster, straight

Pipe dia. R acc. to DIN	FLEXMASTER, complete with NBR seal		FLEXMASTER, complete with FPM seal		Dimensions in mm								Weight approx. [kg]	
	Part No.	DB Code	Part No.	DB Code	E		g		h		L			
2391 2441 2448 2442					b	C	e	min.	max.	min.				
55	GM10009-055	F-55P/102	GM10209-055	F-55V/102	135	89	75	4	8	25	37	17,7	102	
57	GM10009-057	F-57P/102	GM10209-057	F-57V/102	135	89	75	4	8	25	37	17,7	102	
58 2"	GM10009-058	F-58P/102	GM10209-058	F-58V/102	135	89	75	4	8	25	37	17,7	102	0.720
60	GM10009-060	F-60P/102	GM10209-060	F-60V/102	135	89	75	4	8	25	37	17,7	102	
60,3	GM10009-32	F-2P/102	GM10209-32	F-2V/102	135	89	75	4	8	25	37	17,7	102	
63,5	GM10010-40	F-T2 ¹ / ₂ P/102	GM10210-40	F-T2 ¹ / ₂ V/102	137	96	70	8	12	25	37	17,7	102	0.780
65 2	GM10010-065	F-65P/102			137	96	70	8	12	25	37	17,7	102	
70 1/2"	GM10011-070	F-70P/165	GM10211-070	F-70V/165	175	122	95	8	12	40	51	30	165	2.4
73	GM10011-40	F-2 ¹ / ₂ P/165	GM10211-40	F-2 ¹ / ₂ V/165	175	122	95	8	12	40	51	30	165	
75	GM10012-075	F-75P/127	GM10212-075	F-75V/127	178	125	95	8	12	40	51	30	127	
76,1	GM10012-48	F-T3P/127	GM10212-48	F-T3V/127	178	125	95	8	12	40	51	30	127	2.8
80/1	GM10012-080	F-80P/127	GM10212-080	F-80V/127	178	125	95	8	12	40	51	30	127	
88,9 3"	GM10011-48	F-3P/165	GM10211-48	F-3V/165	191	133	102	8	12	40	51	30	165	3.1
90	GM10011-090	F-90P/165	GM10211-090	F-90V/165	191	133	102	8	12	40	51	30	165	
100 3	GM10011-100	F-100P/165			203	151	110	8	12	40	51	30	165	3.4
101,6 1/2"	GM10011-56	F-3 ¹ / ₂ P/165			203	151	110	8	12	40	51	30	165	
108	GM10011-108	F-108P/165	GM10211-108	F-108V/165	218	165	115	8	12	40	51	30	165	
110 4"	GM10011-110	F-110P/165	GM10211-110	F-110V/165	218	165	115	8	12	40	51	30	165	3.7
114,3	GM10011-64	F-4P/165	GM10211-64	F-4V/165	218	165	115	8	12	40	51	30	165	
127	GM10013-80	F-T5P/165			230	174	120	8	12	40	51	30	165	4.1

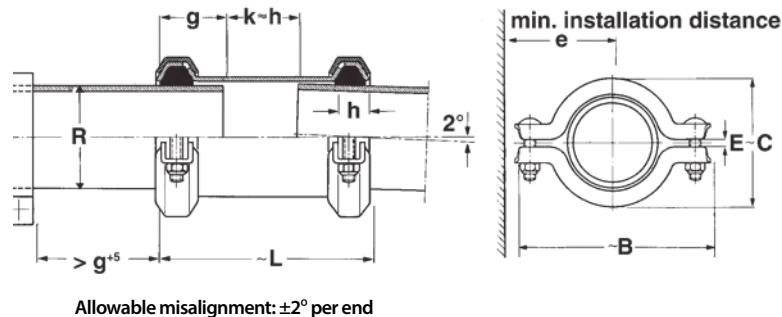

Flexmaster Individual Components

1 Sleeve		2 Seal				3 Seal retainer		4 Clamp complete with bolts	
		NBR		FPM					
Part No.	DB Code	Part No.	DB Code	Part No.	DB Code	Part No.	DB Code	Part No.	DB Code
GM90009-32	H55-60/102=2	GM90210-055	P55	GM90208-055	V55	GM90206-32	D55-60=2	GM90203-32	S55-60=2
GM90009-32	H55-60/102=2	GM90210-057	P57	GM90208-057	V57	GM90206-32	D55-60=2	GM90203-32	S55-60=2
GM90009-32	H55-60/102=2	GM90210-058	P58			GM90206-32	D55-60=2	GM90203-32	S55-60=2
GM90009-32	H55-60/102=2	GM90210-32	P60=2			GM90206-32	D55-60=2	GM90203-32	S55-60=2
GM90009-32	H55-60/102=2	GM90210-32	P60=2			GM90206-32	D55-60=2	GM90203-32	S55-60=2
GM90010-40	H65/102=T2 ^{1/2}	GM90211-40	PT2 ^{1/2}			GM90207-40	D65=T2 ^{1/2}	GM90204-40	S65=T2 ^{1/2}
GM90010-40	H65/102=T2 ^{1/2}	GM90211-065	P65			GM90207-40	D65=T2 ^{1/2}	GM90204-40	S65=T2 ^{1/2}
GM90011-40	H70/165=2 ^{1/2}	GM90210-070	P70	GM90208-070	V70	GM90206-40	D70=2 ^{1/2}	GM90203-40	S70=2 ^{1/2}
GM90011-40	H70/165=2 ^{1/2}	GM90210-40	P2 ^{1/2}			GM90206-40	D70=2 ^{1/2}	GM90203-40	S70=2 ^{1/2}
GM90012-48	H75-80/127=T3	GM90211-075	P75	GM90209-075	V75	GM90207-48	D75-80=T3	GM90204-48	S75-80=T3
GM90012-48	H75-80/127=T3	GM90211-48	PT3	GM90209-48	VT3	GM90207-48	D75-80=T3	GM90204-48	S75-80=T3
GM90012-48	H75-80/127=T3	GM90211-080	P80	GM90209-080	V80	GM90207-080	D75-80=T3	GM90204-48	S75-80=T3
GM90011-48	H89-90/165=3	GM90210-48	P89=3	GM90208-48	V89=3	GM90206-48	D89-90=3	GM90203-48	S89-90=3
GM90011-48	H89-90/165=3	GM90210-090	P90	GM90208-090	V90	GM90206-48	D89-90=3	GM90203-48	S89-90=3
GM90011-56	H100/165=3 ^{1/2}	GM90210-100	P100			GM90206-56	D100=3 ^{1/2}	GM90203-56	S100=3 ^{1/2}
GM90011-56	H100/165=3 ^{1/2}	GM90210-56	P3 ^{1/2}	GM90208-56	V3 ^{1/2}	GM90206-56	D100=3 ^{1/2}	GM90203-56	S100=3 ^{1/2}
GM90011-64	H108-110/165=4	GM90210-108	P108	GM90208-108	V108	GM90206-64	D108-110=4	GM90203-64	S108-110=4
GM90011-64	H108-110/165=4	GM90210-110	P110	GM90208-110	V110	GM90206-64	D108-110=4	GM90203-64	S108-110=4
GM90011-64	H108-110/165=4	GM90210-64	P4	GM90208-64	V4	GM90206-64	D108-110=4	GM90203-64	S108-110=4
GM90013-80	H120-127/165=T5	GM90211-80	PT5			GM90207-80	D120-127=T5	GM90204-80	S120-127=T5



ENGINEERING
TOMORROW



Danfoss Power Solutions, Nordborgvej 81, 6430 Nordborg, Denmark, Tel. +45 74 88 22 22, Fax +45 74 65 25 80
www.danfoss.com, E-mail: info@danfoss.com

Any information, including, but not limited to information on selection of product, its application or use, product design, weight, dimensions, capacity or any other technical data in product manuals, catalogues descriptions, advertisements, etc. and whether made available in writing, orally, electronically, online or via download, shall be considered informative, and is only binding if and to the extent, explicit reference is made in a quotation or order confirmation. Danfoss cannot accept any responsibility for possible errors in catalogues, brochures, videos and other material. Danfoss reserves the right to alter its products without notice. This also applies to products ordered but not delivered provided that such alterations can be made without changes to form, fit or function of the product. All trademarks in this material are property of Danfoss A/S or Danfoss group companies. Danfoss and the Danfoss logo are trademarks of Danfoss A/S. All rights reserved.